

Prisma Light

MOUNTING CITYGRID ON-POLE CONTROLLER

The all-in-one device that can transform existing luminaires it into an intelligent lighting system.

The compact and durable design allows the Citygrid On-pole Controller to be easily installed.

A site can consist of up to 500 units.

Operation of the site can be stand-alone or connected to a cloud solution using the Citygrid Gateway.

FEATURES

- Two motion passive infrared sensors for light control and dimming
- Voltage, current, power and power factor metering
- Astronomical & real-time clock integrated – with Gateway or GPS sensor only.
- Data stored on a flash memory
- Detection of faulty luminaires
- Standby power <1W
- Control output: DALI
- Wireless interconnection between controllers
- Accelerometer and temperature measurement
- AES-128 data encryption

1.

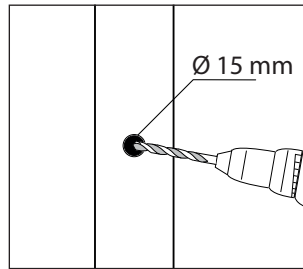

2.

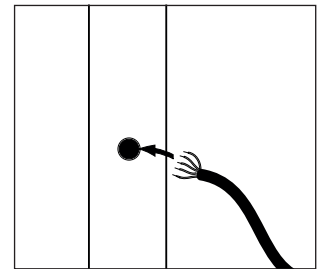

3.

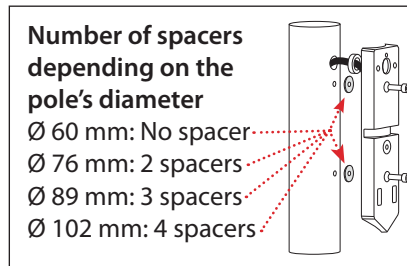

4.

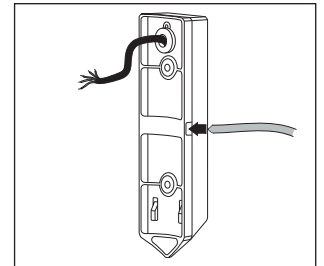

5.

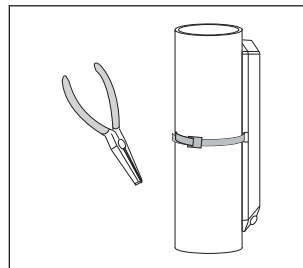

FINAL

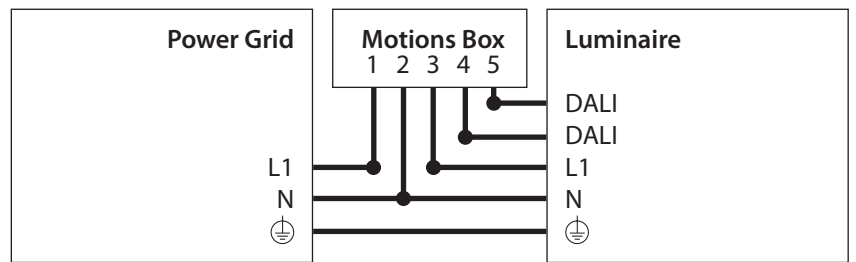
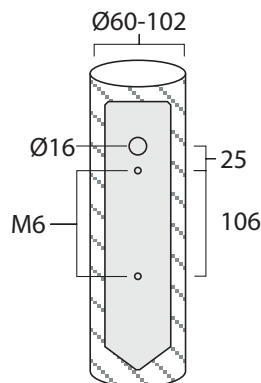
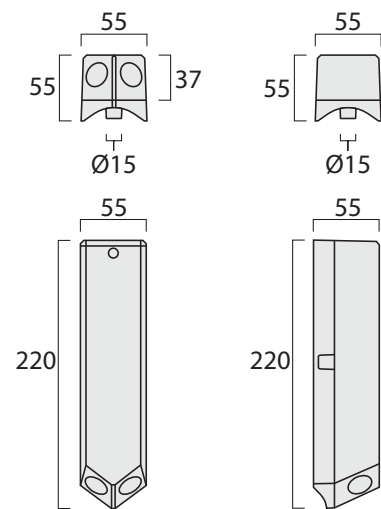
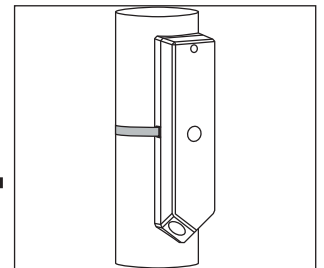

- 1 = L in brown
- 2 = N blue
- 3 = L out grey
- 4 = DALI black
- 5 = DALI black

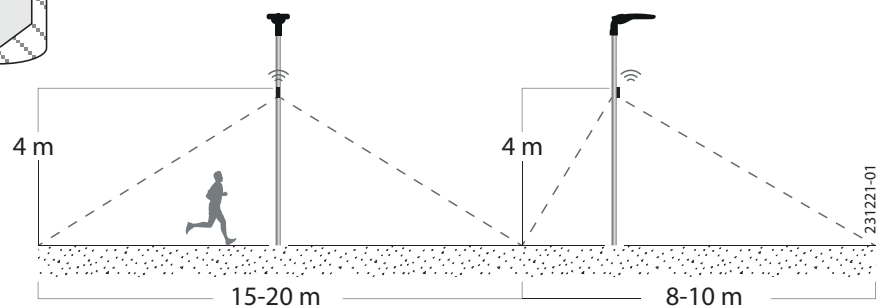
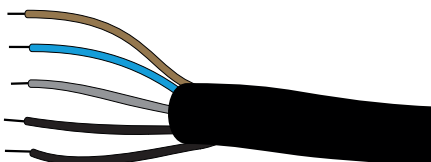

ADRESS Järnvägsgatan 19, 543 50 Tibro
 TEL 0504-400 40
 WEBB prismafibro.se
 E-POST contact@prismafibro.se